

EI-8540 Ages 8+

EI-8545 Ages 3-7

GEO SAFARI[®] LAPTOP[™]



Instruction Guide

GeoSafari® Laptop™

Table of Contents

Operating Your Laptop Machine	1
Let's Look at Laptop	2
Using Your Laptop	4
Single-Player Game:	4
Enter the Code	4
—Changing the Default Program	
—Changing the Response Time	
Starting Play	5
Ending and Scoring a Game	6
Review Option	7
Playing Another Game	7
Two-Player Game:	8
Enter the Code & Mode	8
—Changing the Response Time	
—Setting Bonus Points	
Starting Play	10
Ending the Game	11
Playing Another Game	11
Two-Player Head-to-Head Game:	12
Enter the Code & Mode	12
—Changing the Default Program	
—Changing the Response Times	
—Setting Bonus Points	
Starting Play	14
Scoring a Head-to-Head Game	14
Ending the Game	15
Playing Another Game	15
Troubleshooting	16

Operating Your Laptop™ Machine

Laptop is packed with features that will help you learn and remember all kinds of interesting and useful information—while you're having fun! This guide will show you how to make the most of **Laptop**.

Installing Batteries

For the best operation, always use fresh alkaline batteries.

1. Carefully loosen the screw to open the battery compartment door, located on the back of your machine.
2. Install four fresh AA batteries in the battery compartment, as shown.
3. Close the compartment door and tighten the screw.

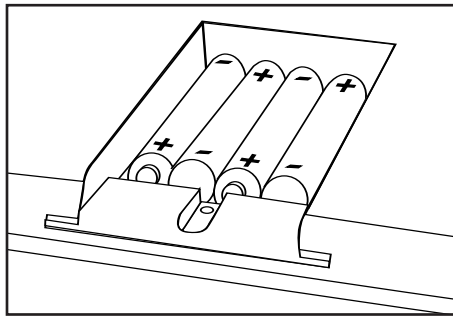

NOTE: Remove batteries if the machine will not be used for a long time.

1. Cleaning Instructions: Clean product with a damp or dry cloth—do not immerse or spray any liquid or water on product.
2. Do not use rechargeable batteries.
3. Non-rechargeable batteries are not to be recharged.
4. Do not mix old and new batteries.
5. Do not mix different types of batteries: alkaline, standard (carbon zinc) or rechargeable (nickel-cadmium) batteries.
6. Only batteries of the same or equivalent type are to be used.
7. Batteries must be inserted with the correct polarity.
8. Remove exhausted batteries from the unit.
9. The supply terminals are not to be short-circuited.
10. To prevent corrosion and possible damage to the product, it is recommended to remove the batteries from the unit if it will not be used for more than two weeks.

Let's Look at

Note:

- If you forget to turn your **Laptop** machine off, it will shut off automatically in five minutes.

- **Card Storage**

- **Enter Code Light Prompt**

This light flashes by the upper left-hand corner of a card next to the code. Enter this number.

- **Question Lights**

During a game, these 20 side lights show which question to answer. At the end of the game, they indicate questions incorrectly answered.

- **Left GO Light**

This flashing GO light identifies Player A, on the left.

- **Left GO Pad**

Press the left GO pad when the left GO light is flashing to start a game or to have **Laptop** choose the next question.

- **ON**

Press this key to turn on the machine.

- **OFF**

Press this key to turn off the machine.

- **VOLUME**

Press here to increase volume.

Press here to decrease volume.

Laptop™

• **Display Window**
This shows entered codes, programming prompts, answers, score(s), and time remaining to answer.

• **CLEAR**
Press once if you would like to change an answer before pressing \downarrow . Press twice to end a game and begin a new one.

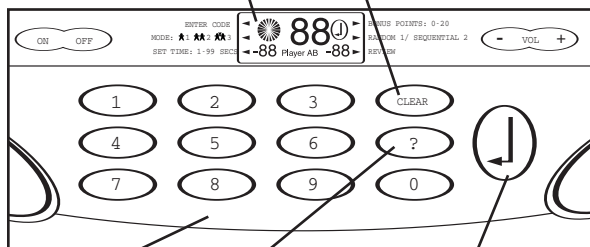

• **Keyboard**
with numbers 0–9

• **?**
Press to reveal the correct answer.

• **\downarrow**
Press after selecting and entering numbers, answers, letters, or codes.

• **Right GO Light**
This flashing GO light identifies Player B, on the right.

• **Right GO Pad**
Press the right GO pad when the right GO light is flashing to start a game or to have **Laptop** choose the next question.

Display Window Step-by-Step Instructions and Responses:

ENTER CODE

[Enter a code and press \downarrow to continue programming]

MODE: * 1 * 2 * 3

[Enter a number and press \downarrow to continue programming]

SET TIME: 1-99 SECS

[Enter a response time and press \downarrow to continue programming]

BONUS POINTS: 0-20

[0 Player A for the Player on the left—enter number of points and press \downarrow to continue programming]

[0 Player B for the Player on the right—enter number of points and press \downarrow]

RANDOM 1/SEQUENTIAL 2

Enter either 1 or 2 and press \downarrow . The default is for random play.

REVIEW

[Available in Mode 1 only]

Using Your Laptop™

Laptop games can be played in three different modes:

- Mode 1—Single-Player Game
- Mode 2—Two-Player Game
- Mode 3—Two-Player “Head-to-Head” Game

On the following pages you’ll find directions for using **Laptop** in each of the three modes.

Single-Player Game (Mode 1)

*A single-player game is just between you and **Laptop**!*

Here’s how to play:

Choose a lesson and place it on the machine. Press the ON button on the keyboard. You’ll hear a musical salute, the question lights will blink, the display window will greet you with “Hi,” and a prompt arrow in the window will point to ENTER CODE.

ENTER THE CODE

Enter the four-digit code located in the upper left-hand corner of the lesson card. (The machine will sound an error if the code is not entered correctly.)

After the code is entered, the green GO lights will flash. The game can be started right away (in the default program) by pressing either GO pad.

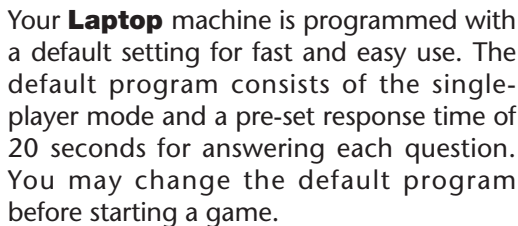

Your **Laptop** machine is programmed with a default setting for fast and easy use. The default program consists of the single-player mode and a pre-set response time of 20 seconds for answering each question. You may change the default program before starting a game.

Changing the Default Program

If you want to change any part of the default programming, press \downarrow after entering the code. The prompt arrow will first flash next to MODE: * 1 * 2 ** 3. A numeral 1 (for Mode 1) will appear in the display window.

- To stay in Mode 1, simply press \downarrow .
- To change mode, enter 2 or 3 and then press \downarrow .

(If you change modes, see separate directions for playing those games.)

Changing the Response Time

Next, the prompt arrow will flash next to SET TIME: 1-99 SECS. The number 20 will appear in the display window. (This is the default time for the number of seconds a player has to answer a question.)

- To change your response time, enter a new time setting (from 1-99 seconds) and press \downarrow .

After pressing \downarrow , both GO lights will flash. Press either of the GO pads to start your game.

STARTING PLAY

After either GO pad is pressed, the question lights will blink in random order, then stop at a question.

Always
read the directions
near the top of the
card before you
begin play!

Play Guidelines

1. Read the question next to the flashing light.



Keep Your Eye on the Clock! After the flashing light has stopped by a question, a “countdown clock” will appear on the left-hand side of the display window. As it counts down, this clock shows the time remaining for answering the question. You’ll hear a ticking sound when 5 seconds are left.

2. Answer the question by entering the appropriate number key(s), then pressing ↵. (The ↵ prompt symbol will flash in the display window.)

Note: If you wish to change an answer before pressing ↵, press CLEAR, re-enter the answer, and press ↵.

- If your answer is correct, a musical salute will sound. Congratulations!
- If your answer is incorrect, you'll hear an error tone. But you can try again! **Laptop** gives you three chances to answer each question.

If a question is not answered before the clock runs out, an error tone will sound and the correct answer will appear in the display window.

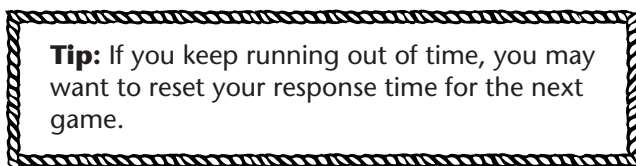

At the end of each turn, your score will appear in the lower left-hand corner of the display window.

3. Press either GO pad for the next question.

ENDING AND SCORING A GAME

A game is over when all the questions in the lesson have been presented and the final musical salute has been heard. If every question has been answered correctly, you'll also see a congratulatory light show! The final score will appear in the lower left-hand corner of the display window. The total score a player can earn depends on the number of questions on the card.

How Games Are Scored

- A correct answer on the first try earns 3 points.
- A correct answer on the second try earns 2 points.
- A correct answer on the third try is worth 1 point.

REVIEW OPTION

Laptop lets you practice 'til you get it right!

At the end of a game, red lights will blink next to any questions that were answered incorrectly, and the prompt arrow will flash next to REVIEW in the display window. If you want to replay your missed questions, press either GO button. The questions you missed in the game will be presented randomly, and you'll have another chance to answer correctly!

- If a question is answered correctly (one try only), you'll hear a musical salute.
- If a question is answered incorrectly, an error tone will be heard, the correct answer will appear in the display window, and the red light by that question will remain lit.

When all of the missed questions have been presented, you'll hear another musical salute. If any questions still were not answered correctly, the prompt arrow will flash next to REVIEW and the red lights will flash next to those missed questions. Press GO to continue the review cycle. The review sequence may be continued until all missed questions have been answered correctly, until the CLEAR button is pressed twice, or until the machine is turned off.

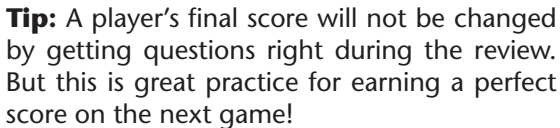

Tip: A player's final score will not be changed by getting questions right during the review. But this is great practice for earning a perfect score on the next game!

PLAYING ANOTHER GAME

You can move easily from one game to the next. Here's how:

Replaying the Same Single-Player Game

The same lesson can be replayed with the same programming by pressing CLEAR twice, and then either GO pad.

Playing a Different Game

To play a different lesson, remove the card and put another lesson on the machine. Press CLEAR twice, and enter the new code.

- If you want to play a single player game with the same response time as your last game, simply press either GO pad to start.

- If you want to change modes, press ↵, enter 2 or 3, then press the GO button under the flashing green GO light. This will start the game with the default programming for that mode.
- If you want to change modes and change any default programming, press ↵ and enter new information at the appropriate prompts. Press GO to start the new game whenever a GO light is flashing.

Two-Player Game (Mode 2)

Any **Laptop** lesson can be played as a two-player game—and can be individualized for players of different skill levels: You can choose different response times for each player and, if you wish, award Bonus Points to one or both players so that a less experienced or younger player can compete with a more experienced player.

Here's how to play:

Choose a lesson and place it on the machine. Press the ON button on the keyboard. You'll hear a musical greeting, the question lights will blink, the display window will say "Hi," and a prompt arrow will point to ENTER CODE.

ENTER THE CODE & MODE

Type in the lesson's four-digit code located in the upper left-hand corner of the card. Press ↵. When the prompt arrow in the display window flashes next to MODE, enter the number 2.

- If the default programming is acceptable to both players (20 second-response time; no Bonus Points), press the left GO pad to start the game right away. (Skip ahead in this guide to "Starting Play" on page 10.)
- Press ↵ if you want to change response times and/or award Bonus Points for either player.

Changing the Response Time

The prompt arrow will flash next to SET TIME: 1-99 SECS. You'll see **20 Player A** (20 for the default time and Player A for the player on the left) in the display window.

- If you want to change the response time for Player A, enter a new time setting (from 1-99 seconds) and press ↵ to continue programming.

The prompt arrow will again flash next to SET TIME: 1-99 SECS. You'll see **20 Player B** (20 for the default time and Player B for the player on the right) in the display window.

- If you want to change the response time for Player B, enter the new time setting (from 1-99 seconds).
 - Press the left GO pad to start the game right away.
 - Press ↵ to set Bonus Points.

Note: Just press ↵ if you want to leave any player's response time at 20 seconds.

Setting Bonus Points

Sometimes less experienced players need a little help when competing with more experienced players. In a 2-player game, you can give another player a head start by giving him or her some Bonus Points to make the game more even. The maximum number of Bonus Points any player may receive is 20.

Here's how to award Bonus Points:

After response times have been entered, the prompt arrow will flash next to BONUS POINTS: 0-20. You'll see **0 Player A** (no Bonus Points currently for Player A) in the display window.

- If no Bonus Points are to be awarded to Player A, press ↵ to move ahead and set Bonus Points for Player B.
- If Bonus Points are to be awarded to Player A, enter the desired number of points. Then . . .
 - Press the left GO pad to start the game right away, or
 - Press ↵ if you want to set Bonus Points for Player B.

If you pressed ↵, the prompt arrow will flash again by BONUS POINTS: 0-20. This time you'll see **0 Player B** (no Bonus Points currently for Player B) in the display window.

- If no Bonus Points are to be awarded to Player B, press the left GO pad to start the game.
- If Bonus Points are to be awarded to Player B, enter the desired number of points.

The left GO light will flash. Player A begins the game by pressing the left GO pad.

STARTING PLAY

As soon as Player A presses the left GO pad, each player's Bonus Points will appear in the display window. The question lights will blink in random order, then stop at a question. Player A begins the game.

Always
read the directions
near the top of the
card before you
begin play!

Play Guidelines

1. Player A reads the first question next to the flashing light.



After the flashing light has stopped by a question, a countdown clock will appear on the left-hand side of the display window. The clock will count down as the player's answer time lapses. During the last five seconds of the response time a ticking sound will signal that time's running out!

2. Player A answers the question by entering the appropriate number key(s), then pressing ↵. (The ↵ prompt symbol will flash in the display window.)
 - If the answer is correct, a musical salute will sound. Good job!
 - If the answer is incorrect, an error tone will be heard. The player has three chances to answer each question within the time allotted.

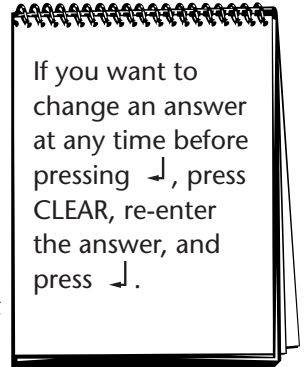

If you want to change an answer at any time before pressing ↵, press CLEAR, re-enter the answer, and press ↵.

Watch the countdown clock! If the question is not answered within the response time, an error tone will sound and the correct answer will appear in the display window.

3. Players' turns alternate with each question. The blinking player GO light shows which player answers the question.
4. Scores are shown and updated throughout the game. Player A's score appears on the left-hand side of the display window, and Player B's score on the right-hand side. The scores include Bonus Points if they were awarded at the beginning of the game.

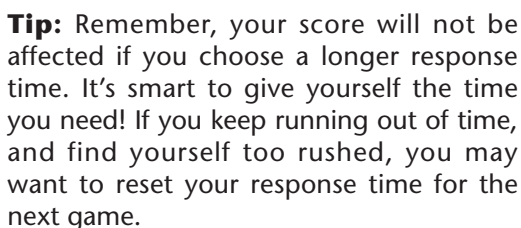

Tip: Remember, your score will not be affected if you choose a longer response time. It's smart to give yourself the time you need! If you keep running out of time, and find yourself too rushed, you may want to reset your response time for the next game.

ENDING THE GAME

Your 2-player game is over when all questions in the lesson have been presented. If Player A has earned a perfect score, a musical salute will sound, a light display will blink, and Player A's final score will be shown in the display window. If Player B has a perfect score, the same congratulatory sequence will occur.

If a player has missed any questions, there will be no light display. Instead, the question(s) missed will be highlighted by blinking question lights as that player's score is displayed.

The two players' score-and-light displays will continue alternating until CLEAR has been pressed twice, or the machine is turned off.

Note: There is no REVIEW of missed questions available for Mode 2.

PLAYING ANOTHER GAME

It's easy to move from one game to another. Read on . . .

Replaying the Same Two-Player Game

The same lesson can be replayed with the same programming by simply pressing CLEAR twice, and then either GO pad.

Playing a Different Game

To play a different lesson, remove the card, and put another lesson on the machine. Press CLEAR twice, and enter the new code.

- If you want to play a two-player game with the same response times and Bonus Points as your last game, press the left flashing GO pad to start.
- If you want to change modes, press \downarrow , then enter 1 or 3 and press the GO button under the flashing green GO light. This will start the game with the default programming for that mode.

- If you want to change modes and change any default programming, press ↵ after entering the mode, and then enter new information at the appropriate prompts. Press GO to start the new game whenever a GO light is flashing.

Two-Player Head-to-Head Game (Mode 3)

In a Head-to-Head game, each question is up for grabs! After a question is presented, the player who hits the GO pad first gets to answer—for 3 points. But watch out! If you are wrong, you'll lose 1 point! Your opponent can then choose to give the question a try. If correct, he or she gets 2 points. If incorrect, 1 point is lost.

Here's how to play:

Any **Laptop** lesson can be played as a head-to-head game. Choose a lesson and place it on the machine. Press the ON button on the keyboard. You'll hear a musical greeting, the question lights will flash, the display window will greet players with "Hi," and a prompt arrow will point to ENTER CODE.

ENTER THE CODE & MODE

Enter the four-digit code located in the upper left-hand corner of the card. Press ↵. When the prompt arrow in the window flashes next to MODE, enter the number 3. Both players' GO lights will flash slowly. The game can be started right away (in the default program) by pressing either GO pad.

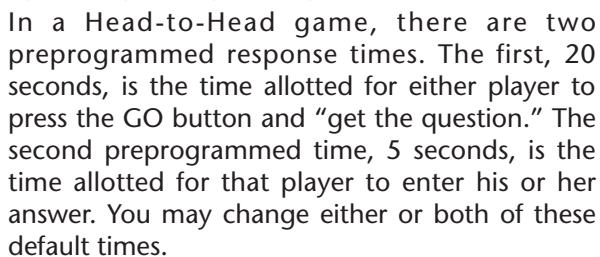

In a Head-to-Head game, there are two preprogrammed response times. The first, 20 seconds, is the time allotted for either player to press the GO button and "get the question." The second preprogrammed time, 5 seconds, is the time allotted for that player to enter his or her answer. You may change either or both of these default times.

Changing the Default Program

Press \downarrow after selecting Mode 3 and follow these directions:

Changing the Response Times

The prompt arrow will flash next to SET TIME, and you'll see **20 Player A, Player B 1** (the default time of 20 seconds for the first response time for both players) in the display window. If you want a response time other than 20 seconds (from 1-99 seconds), enter it and press \downarrow to continue programming.

Note: Remember, this response time will be the same for both players. Therefore, both players must agree to it.

The prompt arrow will again flash next to SET TIME, and you'll see **5 Player A, Player B 2** in the display window. This indicates the time (5 seconds) allotted for the player who "gets the question" to enter an answer and press \downarrow . If you want a response time other than 5 seconds, enter the appropriate numerals.

Note: This response time will also be the same for both players.

- If you want to award Bonus Points, press \downarrow to continue programming.
- If you don't want to award Bonus Points and you're ready to get into the game, either player may press GO when both GO lights start flashing. (Skip ahead in this guide to "Starting Play" on page 14.)

Setting Bonus Points

You may award from 1 to 20 Bonus Points per player.

The prompt arrow will flash next to BONUS POINTS 0-20. You'll see **0 Player A** (no Bonus Points currently for Player A) in the display window.

- If no Bonus Points are to be awarded to Player A, press \downarrow to move ahead and set Bonus Points for Player B.
- If Bonus Points are to be awarded to Player A, enter the desired number of points. Then . . .
 - Press the left GO pad to start the game right away, or
 - Press \downarrow if you want to set Bonus Points for Player B.

If you pressed \downarrow , the prompt arrow will flash again by BONUS POINTS: 0-20. You'll see **0 Player B** (no Bonus Points currently for Player B) in the display window.

- Enter the desired number of points. Whenever both GO lights are flashing, the game can be started.

STARTING PLAY

Once any programming changes have been entered, either player may press GO to start the game. When the question lights stop at a question, the countdown clock will appear in the display window and begin to count down. Bonus points will also appear if they have been awarded.

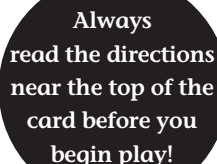

Always
read the directions
near the top of the
card before you
begin play!

Play Guidelines

Always read the directions near the top of the card before you answer any questions.

1. Both players read the question next to the flashing light.
2. The first player to press his/her GO pad within the allotted time gets to answer first.
3. When the first player presses GO, a series of musical notes will sound and that player's GO light will flash. That player then has a specific amount of time in which to enter an answer and press.
↓ Watch the clock!

If the answer is correct, the player earns 3 points. The GO lights will flash for both players, and either player can press GO to go on to the next question.

SCORING A HEAD-TO-HEAD GAME

If the first player's answer is wrong, or if the time to answer runs out without an answer being entered, a point is subtracted from that player's score. A "whooping" sound will be heard and the second player's GO light will come on. This alerts the second player that he/she now has a chance to answer the question. If the second player decides to answer the question, he/she keys in an answer and presses ↓.

- If the question is answered correctly in the available time, that player receives 2 points.
- If the second player answers incorrectly, a point is subtracted from his/her score.
- If the second player decides not to answer the question at all, no answer is entered, and his/her score will remain the same.

What if neither player wants to take a chance with a question?

If neither GO pad is pressed after a question has been selected, the scores remain the same and no points are added or subtracted from either player's score. When the clock runs out, the machine will sound the error tone, the answer will show on the screen, and both GO lights will flash. This signals that either player may press GO to continue the game.

ENDING THE GAME

The head-to-head game is over when all the questions in the lesson have been presented and the ending musical salute has been heard. At the end of the game, the lights will blink by the questions not answered and the questions missed. If all of the questions were answered correctly, there is a light display after the ending musical salute. The scores for each player are displayed throughout the game.

Note: There is no REVIEW in Mode 3.

PLAYING ANOTHER GAME

Here's how to continue game play:

Replaying the Same Head-to-Head Game

The same lesson can be replayed with the same programming by pressing CLEAR twice, and then either GO pad.

Playing a Different Game

To play a different lesson, remove the card, and put another lesson on the machine. Press CLEAR twice, and enter the new code.

- If you want to play a head-to-head game with the same response times and Bonus Points as your last game, press either flashing GO pad to start.
- If you want to change mode, press ↓, then enter 1 or 2 and press the GO button under the flashing green GO light. This will start the game with the default programming for that mode.
- If you want to change modes and change any default programming, press ↓ after entering the mode, and then enter new information at the appropriate prompts. Press GO to start the new game whenever a GO light is flashing.

Troubleshooting

If your **Laptop** machine fails to operate properly, check the batteries. Weak batteries can cause a variety of malfunctions. Dim lights are the first sign of weak or drained batteries. Replace the batteries with a fresh set. If your unit will not be used for a long period of time, remove the batteries to prevent possible corrosion.

WARRANTY INFORMATION

Dear Customer,

Thank you for purchasing **GeoSafari Laptop**. We're certain that you and your children will enjoy the learning experiences offered by this electronic product.

Educational Insights products are guaranteed to function for one year. Educational Insights warrants each unit against factory defects in material and workmanship for one year from the date of purchase to the original retail purchaser only.

Educational Insights's sole and exclusive liability for defects in material and workmanship shall be limited to repair or replacement at an authorized Educational Insights service center. This warranty does not obligate Educational Insights to bear the cost of transportation charges in connection with the repair or replacement of defective parts.

This warranty does not cover any claim concerning worn-out or defective batteries.

If your **GeoSafari Laptop** fails to operate satisfactorily during the first year after purchase, return it postage prepaid with your check or money order for \$6.50 for handling and inspection. Be sure to include the product, your name, address, and a brief description of the problem. Send this information to the factory service center listed below. If this unit is found to be defective within the first year, it will be repaired or replaced at no further cost to you.

OUT OF WARRANTY SERVICE POLICY

If your unit requires service after expiration of the one-year, limited-warranty period, Educational Insights will service or replace it with a reconditioned unit—at our option—upon receipt of the unit and your check or money order for \$20.00.

EI-8540/8545 **GeoSafari Laptop** \$20.00 plus \$6.50 shipping and handling

SERVICE CENTER

Direct all returns to:

Educational Insights, Inc.
Customer Service Dept.
2206 Oakland Parkway
Columbia, TN 38401-9901

Customer Service (800) 995-4436

CANADIAN CUSTOMERS:

Charges are listed in U.S. dollars. Please send Canadian dollars in U.S. equivalent, plus \$6.50 for postage and handling fee.

This device complies with Part 15 of the FCC rules. Operation is subject to the following two conditions: (1) this device may not cause harmful interference, and (2) this device must accept any interference received, including interference that may cause undesired operation.

Warning: Changes or modifications to this unit not expressly approved by the party responsible for compliance could void the user's authority to operate the equipment.

NOTE: This equipment has been tested and found to comply with the limits for a class B digital device, pursuant to Part 15 of the FCC rules. These limits are designed to provide reasonable protection against harmful interference in a residential installation. This equipment generates, uses, and can radiate radio frequency energy and, if not installed and used in accordance with the instructions, may cause harmful interference to radio communications. However, there is no guarantee that interference will not occur in a particular installation. If this equipment does cause harmful interference to radio or television reception, which can be determined by turning the equipment off and on, the user is encouraged to try to correct the interference by one or more of the following measures:

- Reorient or relocate the receiving antenna.
- Increase the separation between the equipment and receiver.
- Connect the equipment into an outlet on a circuit different from that to which the receiver is connected.
- Consult the dealer or an experienced radio/TV technician for help.



© Copyright 2005 Educational Insights, Inc.
18730 S. Wilmington Ave., Rancho Dominguez, CA 90220
All rights reserved. Please retain this information.
Conforms to ASTM F-963, FCC Part 15.
Made in China.

TELL EDUCATIONAL INSIGHTS: We welcome your comments or questions about our products or service.
CALL: (800) 995-4436 Monday-Friday
WRITE TO: Educational Insights Customer Service, 2206 Oakland Parkway, Columbia, TN 38401-9901(USA)
EMAIL: service@edin.com **OR VISIT OUR WEBSITE:** www.educationalinsights.com